

PRECAUTIONS	3	Using the accessories	12
General safety instructions	3	Using the hob	12
Installation	7	Using the storage compartment (where present)	13
Appliance purpose	8	Using the oven	13
This user manual	8	Digital programmer	14
Manufacturer's liability	8	Cooking advice	16
Identification plate	8	Cooking information table	17
Disposal	8	CLEANING AND MAINTENANCE	18
Information for European Control Bodies	8	Cleaning the appliance	18
To save energy	8	Cleaning the hob	18
Light sources	9	Knobs	19
How to read the user manual	9	Cleaning the door	19
DESCRIPTION	9	Cleaning the oven cavity	20
General description	9	Vapor Clean (on some models only)	21
Hob	10	Extraordinary maintenance	21
Control panel	10	INSTALLATION	22
Other parts	10	Gas connection	23
Accessories	11	Burner and nozzle characteristics tables	25
USE	12	Positioning	25
Preliminary operations	12	Electrical connection	28
		Instructions for the installer	28

We advise you to read this manual carefully, which contains all the instructions for maintaining the appliance's aesthetic and functional qualities. For further information on the product: www.smeg.com

PRECAUTIONS

General safety instructions

Risk of personal injury

- During use the appliance and its accessible parts become very hot. Keep children well away from the appliance.
- Protect your hands by wearing oven gloves when moving food inside the oven.
- Never try to put out a fire or flames with water: Turn off the appliance and smother the flames with a fire blanket or other appropriate cover.
- This appliance may only be used by children aged 8 years and over, and by people of reduced physical, sensory or mental capacity, or lacking in experience in the use of electrical appliances, provided that they are supervised or have been given instructions on the safe use of the appliance and of the hazards associated with it.
- Children must not play with the appliance.
- Keep children under the age of eight at a safe distance unless they are constantly supervised.
- Keep children under the age of 8 away from the appliance

when it is in use.

- Cleaning and maintenance must not be carried out by unsupervised children.
- Make sure that the flame-spreader crowns are correctly positioned in their housings with their respective burner caps.
- Be aware of how rapidly the cooking zones heat up. Do not place empty pans on the heat. Danger of overheating.
- The cooking process must always be kept under control. A short cooking process must be continuously monitored.
- Fats and oils can catch fire if they overheat. Do not leave the appliance unattended while preparing foods containing oils or fats. If fats or oils catch fire, never put water on them. Place the lid on the pan and turn off the relevant cooking zone.
- Do not place metal objects, such as dishes or cutlery, on the surface of the hob during cooking as they may overheat.
- **WARNING:** leaving food unattended when cooking using fat or oil can be dangerous and can cause a fire. **DO NOT** attempt to extinguish a fire with water. Turn off the appliance and smother the flames, for example with a lid or a blanket.
- The appliance becomes very hot during use. Take care never

to touch the heating elements inside the oven(s).

- Do not insert pointed metal objects (cutlery or utensils) into the slots in the appliance.
- Do not pour water directly onto very hot trays.
- Keep the oven door closed during cooking.
- If you need to move food or at the end of cooking, open the door 5 cm for a few seconds, let the steam come out, then open it fully.
- The surfaces inside the storage compartment (where fitted) may become very hot.
- Do not open the storage compartment (where present) when the oven is on and still hot.
- The items inside the storage compartment (where present) could be very hot after the oven has been used.
- Do not rest any weight or sit on the open door of the appliance.
- Switch off the appliance immediately after use.
- Do not pull the cable to unplug the appliance (if installed).
- **DO NOT USE OR STORE FLAMMABLE MATERIALS IN THE STORAGE COMPARTMENT (IF AVAILABLE) OR NEAR THE APPLIANCE.**
- **DO NOT USE AEROSOLS IN**

THE VICINITY OF THIS APPLIANCE WHILST IT IS IN USE.

- DO NOT MODIFY THIS APPLIANCE.
- Always wear personal protective equipment (PPE) before carrying out any work on the appliance (installation, maintenance, positioning or moving).
- Do not clean the appliance if it is still hot or in operation.
- Before performing any work on the appliance, switch off the power supply.
- **WARNING:** Make sure that the appliance has been switched off and disconnected from the mains power supply or that the mains power has been switched off before replacing the interior lighting bulbs.
- The bulbs used in this appliance are specific for household appliances; do not use them for home lighting.
- Installation and servicing should be carried out by qualified personnel in accordance with current standards.
- Do not try to repair the appliance yourself or without the assistance of a qualified technician.
- If the power cable becomes damaged, contact technical support immediately to arrange for it to be replaced in order to

avoid possible hazards.

- **WARNING:** A gas cooking appliance produces heat, humidity and combustion products in the room where it is installed. Make sure the kitchen is well ventilated, especially when the appliance is in use: keep the natural ventilation openings open or install a mechanical ventilation device.
- Intensive and prolonged use of the appliance may require additional ventilation, for example opening a window or more effective ventilation; for example by increasing the power of any mechanical suction devices.

Risk of damaging the appliance

- Do not use harsh or abrasive detergents or sharp metal scrapers to clean the glass door of the oven since they may scratch the surface and cause the glass to shatter.
- Use wooden or plastic utensils.
- Do not use steam jets to clean the appliance.
- Do not obstruct ventilation openings and heat dispersal slots.
- Do not sit on the appliance.
- Racks and trays should be inserted as far as they will go into the side guides. The mechanical safety locks that prevent them from being

removed must face downwards and towards the back of the oven.

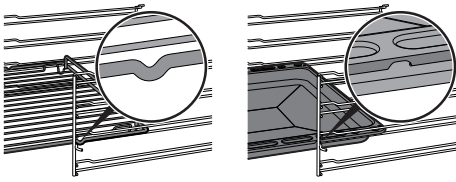

- CAUTION: Never leave the appliance unattended when cooking using fats or oils. Risk of fire. Be very careful.
- Risk of fire: Do not store objects on the cooking surfaces.
- Do not spray any spray products near the oven.
- DO NOT FOR ANY REASON USE THE APPLIANCE AS A SPACE HEATER.
- Do not use plastic kitchenware or containers for cooking.
- Do not put sealed tins or containers in the oven.
- Remove all trays and racks which are not required during cooking.
- Do not cover the bottom of the oven cavity with aluminium or tin foil sheets.
- Do not place pans or trays directly on the bottom of the oven cavity.
- If necessary, you can use the tray rack (supplied or sold separately, depending on the model) by placing it on the bottom as a support for cooking.
- If you wish to use greaseproof

paper, place it so that it will not interfere with the hot air circulation inside the oven.

- Do not use the open door to rest pans or trays on the internal glass pane.
- Cooking vessels or griddle plates should be placed inside the perimeter of the hob.
- All pans must have smooth, flat bottoms.
- If any liquid does boil over or spill, remove the excess from the hob.
- Take care not to spill acid substances such as lemon juice or vinegar on the hob.
- Do not use steam jets to clean the appliance.
- Do not put empty pans or frying pans on switched on cooking zones.
- Do not use rough or abrasive materials or sharp metal scrapers.
- Do not use cleaning products containing chlorine, ammonia or bleach on parts made of steel or that have metallic surface finishes (e.g. anodizing, nickel- or chromium-plating).
- Do not wash removable parts such as the hob pan support grids, flame-spreader crowns and burner caps in the dishwasher.
- Never use the oven door to lever the appliance into place when fitting.

- Avoid exerting too much pressure on the door when open.
- Take care that no objects are stuck in the doors.
- Do not use the handle to lift or move this appliance.

Installation

• THIS APPLIANCE **MUST NOT BE INSTALLED** IN BOATS OR CARAVANS.

- This appliance must not be installed on a pedestal.
- Do not use the handle to lift or move the appliance.
- Position the appliance into the cabinet cut-out with the help of a second person.
- To avoid potential overheating, the appliance must not be installed behind a decorative door or a panel.
- Before installation, make sure that the local distribution conditions (type and pressure of the gas) and the regulation of the appliance are compatible.
- This appliance is not connected to a system for extracting combustion products. It should be installed and connected in compliance with current installation regulations. Pay particular attention to the requirements regarding ventilation.
- The settings for this appliance are shown on the gas setting label.
- Have the gas connection performed by authorised personnel.
- Installation using a hose must be carried out so that the length of the hose does not exceed 2 metres when fully extended for steel hoses and 1.5 metres for rubber hoses.
- The gas connection hoses must not come into contact with moving parts of the built-in module (for example a drawer) and must not be routed through a space that could cause it to be pinched.
- If required, use a pressure regulator that complies with current regulations.
- After carrying out any operation, check that the tightening torque of gas connections is between 10 Nm and 15 Nm.
- At the end of the installation, check for any leaks with a soapy solution, never with a flame.
- Have the electrical connection performed by authorised technicians.
- The appliance must be connected to earth in compliance with electrical system safety standards.
- Use cables that can withstand temperatures of at least 90°C.
- The tightening torque of the

screws of the terminal supply wires must be 1.5 - 2 Nm.

- This appliance can be used up to a maximum altitude of 2,000 metres above sea level.

For this appliance

- The swing doors are not held in place when open and may tend to close again. During use, pay attention not to come into contact with the internal glass pane to prevent burns.

Appliance purpose

This appliance is intended for cooking food in the home environment. Every other use is considered inappropriate. It cannot be used:

- in employee kitchens, shops, offices and other working environments.
- in farms/farmhouses.
- by guests in hotels, motels and residential environments.
- In bed and breakfast accommodation.

This user manual

- This user manual is an integral part of the appliance and must therefore be kept in its entirety and within the user's reach for the whole working life of the appliance.
- Read this user manual carefully before using the appliance.

Manufacturer's liability

The manufacturer declines all liability for damage to persons or property caused by:

- use of the appliance other than that specified;
- failure to comply with the instructions in the user manual;
- tampering with any part of the appliance;

- use of non-original spare parts.

Identification plate

The identification plate bears the technical data, serial number and brand name of the appliance. Do not remove the identification plate for any reason.

Disposal



Power voltage Danger of electrocution

- Disconnect the mains power supply.
- Unplug the appliance.

To dispose of the appliance:

- Cut the power cable and remove it.
- Deliver the appliance to the appropriate recycling centre for electrical and electronic equipment waste, or return it to the retailer when purchasing an equivalent product, on a one for one basis.

Our appliances are packaged in non-polluting and recyclable materials.

- Deliver the packing materials to the appropriate recycling centre.



Plastic packaging Danger of suffocation

- Do not leave the packaging or any part of it unattended.
- Do not let children play with the plastic bags.

Information for European Control Bodies

Fan forced mode

the ECO function used to define the energy efficiency class complies with the specifications of European standard EN 60350-1.

To save energy

- Only preheat the appliance if the recipe requires you to do so.
- Unless otherwise indicated on the package, defrost frozen foods before placing them in the oven.
- When cooking several types of food it is recommended to cook the foods one after the other to make the best use of the already hot oven.
- Use dark metal moulds: They help to absorb

the heat better.

- Remove all trays and racks which are not required during cooking.
- Stop cooking a few minutes before the time normally used. Cooking will continue for the remaining minutes with the heat which has accumulated inside the oven.
- Reduce any opening of the door to a minimum to avoid heat dispersal.
- Keep the inside of the oven clean at all times.

- The light sources contained in the appliance are declared suitable for operation at ambient temperature $\geq 300^{\circ}\text{C}$ and intended for use in high temperature applications such as ovens.
- This appliance contains light sources of efficiency class "G".

Light sources

- This appliance contains user-replaceable light sources.

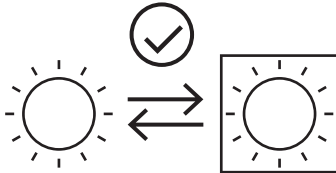

How to read the user manual

This user manual uses the following reading conventions:

	Warning/Caution
	Information/Advice

DESCRIPTION

General description

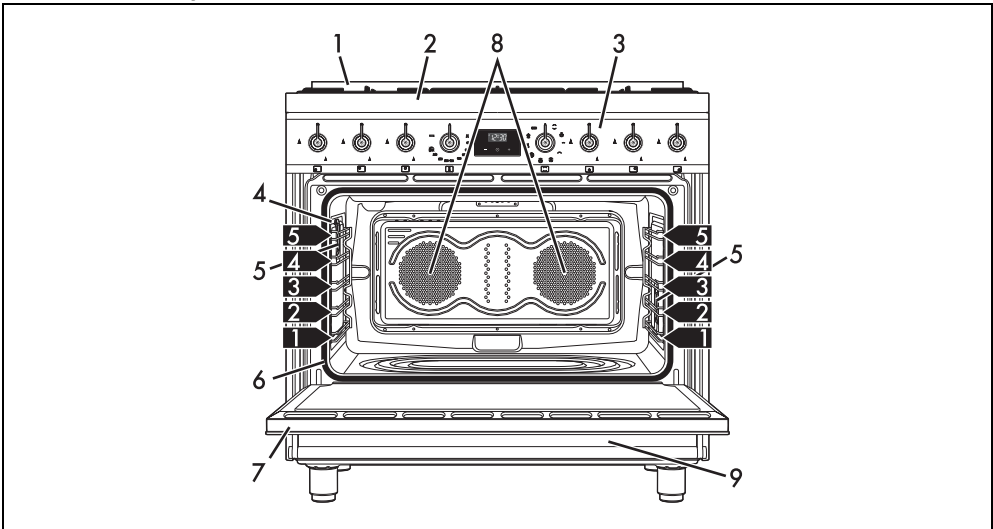

- | | |
|--|--------------------------|
| 1 Upstand | 6 Seal |
| 2 Hob | 7 Door |
| 3 Control panel | 8 Fans |
| 4 Socket for temperature probe (on some models only) | 9 Storage compartment |
| 5 Inside lights | 1,2,3 Frame shelf |

Hob

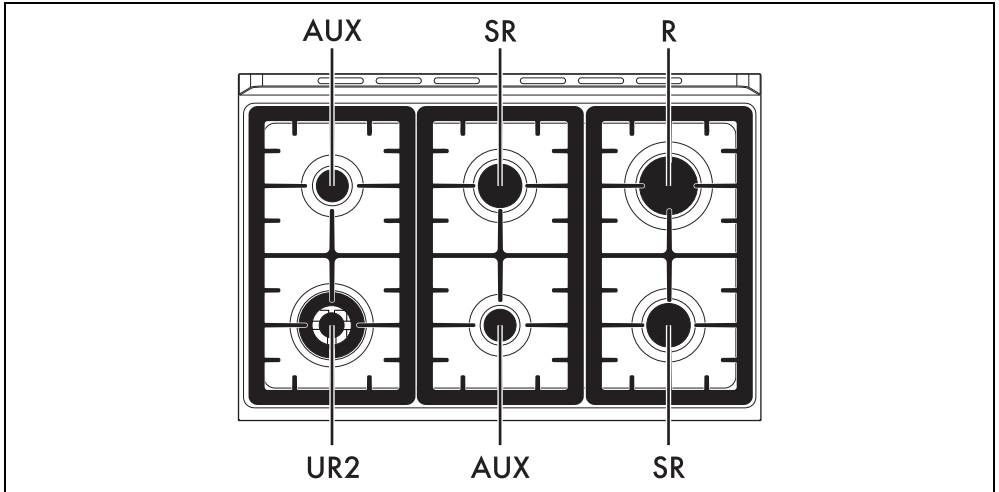



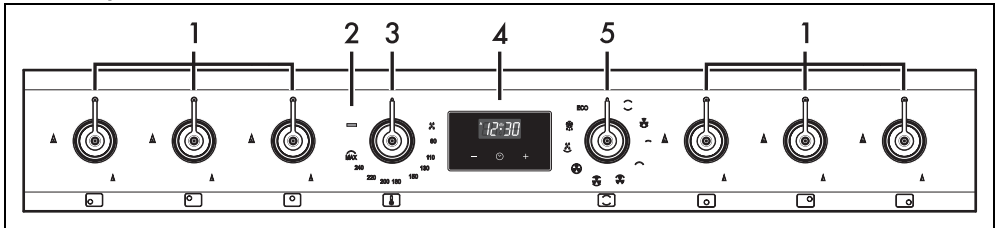

AUX = Auxiliary Burner
SR = Semi-rapid Burner
R = Rapid Burner

UR2 = Ultra Rapid Burner

Control panel



1 Hob burner knobs

For lighting and adjusting the hob burners. Press and turn the knobs anti-clockwise to  in order to light the relative burners. Turn the knobs to the zone between the maximum  and minimum  setting to adjust the flame. Return the knobs to the  position to turn off the burners.

2 Indicator light

The indicator light comes on to indicate that the oven is heating up. It turns off as soon as it reaches the set temperature. It flashes regularly to indicate that the temperature set inside the oven is kept constant.

3 Temperature knob

This knob allows you to select the cooking temperature. Turn the knob clockwise to the required value, between the minimum and

maximum setting.

4 Digital programmer

For displaying the current time, setting programmed cooking operations and the minute minder timer.

5 Function knob

The oven's various functions are suitable for different cooking modes. After selecting the required function, set the cooking temperature using the temperature knob.

Other parts

Shelves

The appliance features shelves to position trays and racks at different heights. The insertion heights are indicated from the bottom upwards (see General description).

Cooling fan

The fan cools the oven and comes into operation during cooking. The fan causes a steady outflow of air that exits from the rear of the appliance and which may continue for a brief period of time even after the appliance has been turned off.



Do not obstruct ventilation openings and heat dispersal slots.

Interior lighting

The appliance's interior lighting comes on:

- When the door is opened.
- When any function is selected, apart from the **ECO** function.



When the door is open, it is not possible to turn off the interior lighting.

Accessories

- Not all accessories are available on some models.
- The accessories intended to come into contact with food are made of materials that comply with the provisions of current legislation.
- Original supplied and optional accessories can be requested to Authorised Assistance Centres. Use only original accessories supplied by the manufacturer.

Trivet

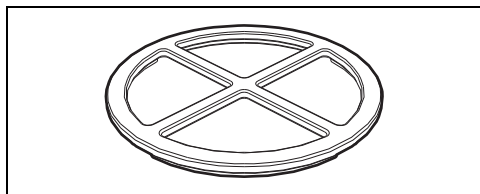

Useful when using small cookware.

Wok support

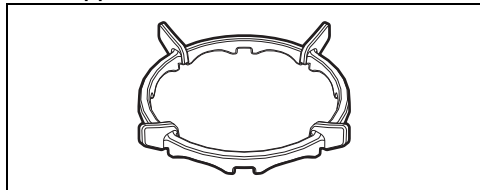

Useful when using a wok.

Deep tray

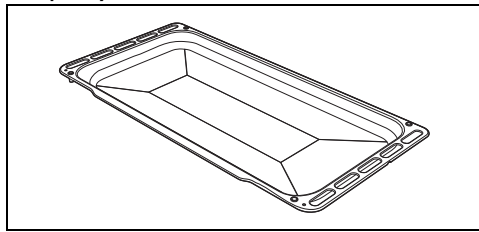

Useful for collecting fat from foods placed on the rack above.

Oven tray

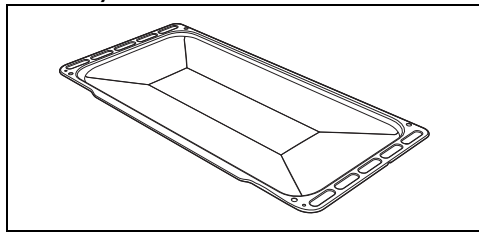

Useful for collecting fat from foods placed on the rack above and for cooking pies, pizzas, baked desserts, biscuits, etc.

Rack

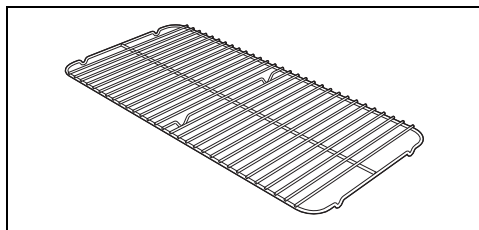

To be placed over the top of the oven tray; for cooking foods which may drip.

Tray rack

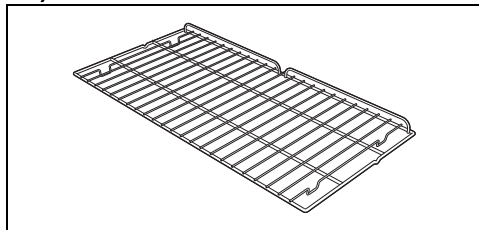

Useful for supporting containers with food during cooking.

USE

Preliminary operations



See General safety instructions.

- Remove any protective film from the outside or inside of the appliance, including accessories.
- Remove any labels (apart from the technical data plate) from the accessories and shelves.
- Remove and wash all the appliance accessories (see chapter "CLEANING AND MAINTENANCE").

First heating

1. Set a cooking time of at least one hour (see paragraph "Using the oven").
2. Heat the empty oven compartment at the maximum temperature to burn off any residues left by the manufacturing process.

When heating the appliance

- air the room;
- don't stay.



Carry out a first pre-heating cycle for each of the cavities in the appliance.

Using the accessories

Racks and trays

Racks and trays have to be inserted into the side guides until they come to a complete stop.

- The mechanical safety locks that prevent the rack from being removed accidentally must face downwards and towards the back of the oven cavity.

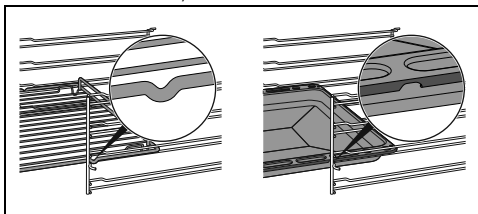

Gently insert racks and trays into the oven until they come to a stop.



Clean the trays before using them for the first time to remove any residues left by the manufacturing process.

Tray rack

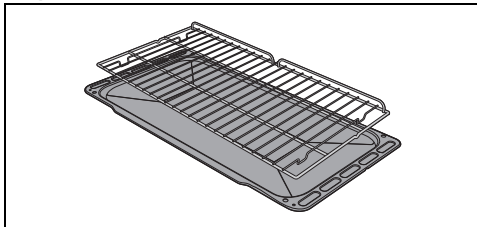

The tray rack has to be inserted into the tray. In this way fat can be collected separately from the food which is being cooked.

Trivets and reduction pan supports

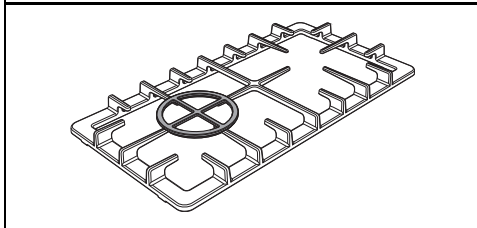
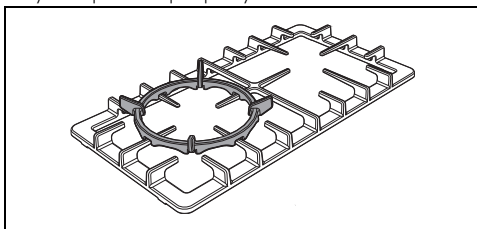

The trivets and reduction pan supports must be placed on the hob pan supports. Make sure they are placed properly.



Using the hob

All the appliance's control and monitoring devices are located together on the front panel. The burner controlled by each knob is shown next to the knob. The appliance is equipped with an electronic ignition device. Simply press the knob and turn it anti-clockwise to the maximum flame symbol, until the burner ignites. If the burner does not light in the first 15 seconds, turn the knob to  and wait 60 seconds before trying again. After lighting, keep the knob pressed in for a few seconds to allow the thermocouple to heat up. The burner may go out when the knob is released: In this case, the thermocouple has not heated up sufficiently.

Wait a few moments and repeat the operation. Keep the knob pressed in longer.

 In case of an accidental switching off, a safety device will be tripped, cutting off the gas supply, even if the gas cock is open. Return the knob to  and wait at least 60 seconds before lighting it again.

Correct positioning of the flame-spreader crowns and burner caps

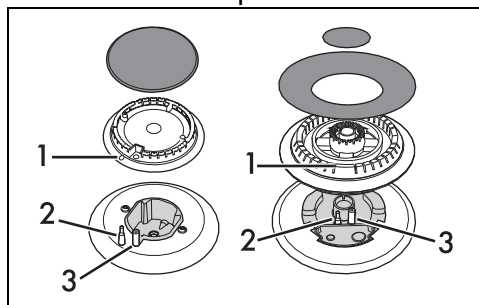

Before lighting the hob burners, make sure that the flame-spreader crowns are correctly positioned in their housings with their respective burner caps. Make sure that the holes 1 in the flame-spreader crowns are aligned with the igniters 3 and thermocouples 2.

Practical tips for using the hob

For better burner efficiency and to minimise gas consumption, use pans with lids and of suitable size for the burner, so that the flames do not reach up the sides of the pan. Once the contents come to the boil, turn down the flame far enough to ensure that the liquid does not boil over.

Burner	Pan diameter
AUX	12 - 14 cm
SR	16 - 24 cm
R	18 - 26 cm
UR2	18 - 28 cm

Using the storage compartment (where present)

 See General safety instructions.

The storage compartment is in the bottom of the cooker. To open it, pull it towards you. It can be

used to store cookware or metallic objects necessary when using the appliance.





Using the oven

 See General safety instructions.

Switching on the oven

To switch on the oven:

1. Select the cooking function using the function knob.
2. Select the temperature using the temperature knob.

 Ensure that the programmer clock shows the cooking duration symbol  otherwise it will not be possible to turn on the oven. Press the  and  buttons at the same time to reset the programmer clock.

List of traditional cooking functions

 Not all functions are available on some models.

STATIC

 Traditional cooking, ideal for preparing a single dish. For example cooking roast meats, fatty meats, bread, pies.

CIRCULAIRE + BOTTOM

 Allows you to quickly finish cooking food that is already cooked on the surface but not internally. Ideal for quiches, suitable for all kinds of dishes.

SMALL GRILL

 Using only the heat released from the central element, this function allows you to grill small portions of meat and fish for making kebabs, toasted sandwiches and any types of grilled vegetable side dishes.

GRILL

 Produces excellent grilling and gratinating results. When used at the end of cooking, gives a uniform browning to dishes.

FAN WITH GRILL



Allows optimal grilling, even for thick slices of meat. Perfect for larger cuts of meat.

FAN ASSISTED



Intense and uniform cooking. Ideal for biscuits, cakes and cooking on more than one level.

CIRCULAIRE



The heat is distributed quickly and uniformly. Suitable for all dishes, ideal for cooking on multiple levels without mixing smells or flavours.

BOTTOM HEAT



The heat comes from the bottom of the cavity. Perfect for cakes, pies, tarts and pizzas.

RAPID DEFROST



Activating the fan on its own ensures a uniform distribution of room temperature air inside the oven, allowing any type of food to be defrosted.

ECO

ECO

This function is particularly suitable for cooking on a single shelf with low energy consumption. It is recommended for all types of food except those that may produce a large amount of moisture (e.g. vegetables). To obtain maximum energy savings and reduce cooking times, it is recommended to place food in the oven without preheating.



When using the ECO function, avoid opening the door during cooking.



Cooking (and preheating) times are longer with the ECO function and may depend on the amount of food in the oven.

VAPOR CLEAN (on some models only)



This function facilitates cleaning using the steam produced by a small amount of water poured onto the depression on the bottom.

Digital programmer

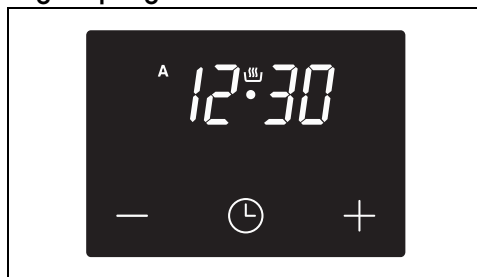

 Decrease key

 Clock key





 Increase key

Setting the time





If the time is not set, the oven will not switch on.

On the first use, or after a power failure, the digits **0:00** will be flashing on the appliance's display.

1. Hold down the clock button  for two seconds. The dot between the hours and the minutes flashes.
2. The time can be set via the increase key  and decrease key . Keep the button pressed to increase or decrease rapidly.
3. Wait 7 seconds. The dot between the hours and the minutes stops flashing.
4. The  symbol on the display indicates that the appliance is ready to start cooking.







To change the time, hold down the increase key  and decrease key  at the same time for two seconds, then set the time.



Timed cooking





Timed cooking is the function which allows a cooking operation to be started and then ended after a specific length of time set by the user.

1. Keep the clock button  pressed until the  symbol appears.
2. Press the clock key  again. On the display the  symbol and the text

dur appear, alternating with the current time.

- Use the increase  and decrease  keys to set the required minutes of cooking.
- Set a function and a cooking temperature.
- Wait approx. 5 seconds without pressing any button in order for the function to activate. The current time and the  and **A** symbols will appear on the display.



At the end of cooking the heating elements will be deactivated. On the display, the  symbol turns off, the **A** symbol flashes and the buzzer sounds.

- To turn the buzzer off, simply press one of the programmer clock buttons.
- Press the clock button  to reset the programmer clock.



It is not possible to set a cooking time of more than 10 hours.







To cancel the set programming press and hold down the increase  and the decrease  keys at the same time and then turn the oven off manually.

Programmed cooking



Programmed cooking is the function which allows a cooking operation to be started at a set time and then ended after a specific length of time set by the user.





- Set the cooking time as described in the previous point Timed cooking.
- Hold the clock key  down for 2 seconds.
- Press the clock key  again. The display will show the digits **0:00** and the text **dur** in sequence, while the **A** symbol flashes (for example, the current time is 17:30).
- Use the  or  key to set the required minutes. (for example 1 hour).
- Press the clock key . The text **End** will appear on the display in sequence with the pre-set cooking duration added to the

current time (for example, the cooking end time shown is 18:30).

- Press the  or  key to set the cooking end time. (for example, 19:30).



Bear in mind that a few minutes for oven preheating must be added to the cooking time.

- Wait approx. 7 seconds without pressing any button in order for the function to activate. The current time appears and the  and  symbols light up on the display.
- Select a cooking temperature and function.
- At the end of cooking the heating elements will be deactivated. On the display, the  symbol turns off, the **A** symbol flashes and the buzzer sounds.
- Return the function and temperature knobs to 0.
- To turn off the buzzer just press any button of the programmer clock.
- Press the  and  buttons at the same time to reset the set program.





It is not possible to set a cooking time of more than 10 hours.



It is not possible to set a programmed cooking time of more than 24 hours.



After setting, hold the clock key  down for 2 seconds to display the cooking time remaining. Press the clock key  again. The display shows the text **dur** and the remaining cooking time in sequence.



Minute minder timer





The minute minder timer does not stop the cooking operation but rather informs the user when the set time has run out.

The minute minder timer can be activated at any time.

- Keep the clock button  pressed for a few seconds. The display shows the figures **0:00** and the  symbol flashing between the hours and minutes.

- Use the increase  and decrease  keys to set the required minutes.
- Wait approx. 5 seconds without pressing any key to finish setting the minute minder.

The current time and the symbols  and  appear on the display.

A buzzer will sound when the set time is reached.

- Press the decrease key  to turn the buzzer off.





The minute minder timer can be set from 1 minute to a maximum of 23 hours and 59 minutes.

Modifying the set data



- Press the clock key .
- Use the increase  and decrease  keys to set the required minutes.

Deleting the set data

- Press the clock key .
- Hold down the increase  and decrease  keys at the same time.
- Then switch off the oven manually if cooking is in progress.

Selecting the buzzer

The buzzer can have 3 tones.

- Hold down the increase  and decrease  keys at the same time.
- Press the clock key .

Press the decrease key  to select a different buzzer tone.

Cooking advice

General advice

- Use a fan assisted function to achieve consistent cooking at several levels.
- It is not possible to shorten cooking times by increasing the temperature (the food could be overcooked on the outside and undercooked on the inside).

Advice for cooking meat

- Cooking times vary according to the thickness and quality of the food and to consumer taste.
- Turn the food to brown on both sides.

- Use a meat thermometer when roasting meat, or simply press on the roast with a spoon. If it is hard, it is ready; if not, it needs to be cooked for a few more minutes.

Advice for cooking with the Grill

- Meat can be grilled even when it is put into the cold oven or into the preheated oven if you wish to change the effect of the cooking.
- With the Fan with grill function (if present), we recommend that you preheat the oven before grilling.
- We recommend placing the food at the centre of the rack.
- With the Grill function, we recommend that you set the temperature to the maximum value to optimise cooking.

Advice for cooking desserts/pastries and biscuits

- Use dark metal moulds: They help to absorb the heat better.
- The temperature and the cooking time depend on the quality and consistency of the dough.
- To check whether the dessert is cooked right through: At the end of the cooking time, put a toothpick into the highest point of the dessert. If the dough does not stick to the toothpick, the dessert is cooked.
- If the dessert collapses when it comes out of the oven, on the next occasion reduce the set temperature by about 10°C, selecting a longer cooking time if necessary.

Advice for cooking on two shelves:

- We recommend using two racks (they can be obtained from Authorised Assistance Centres).
- To facilitate the flow of air, place the moulds/ovenware at the centre of the racks and make sure that their width/diameter does not exceed 30 cm.
- Position the racks keeping an empty shelf between them.
- Depending on the type of food and the increased quantity in the oven, cooking on two levels may take slightly longer compared to cooking on a single shelf.
- We suggest using the following functions when cooking on two shelves: CIRCULAIRE and CIRCULAIRE+BOTTOM.

Advice for defrosting and proving

- Place frozen foods without their packaging in a lidless container on the first shelf of the oven.
- Avoid overlapping the food.
- To defrost meat, use the rack placed on the second level and a tray on the first level. In

this way, the liquid from the defrosting food drains away from the food.

- The most delicate parts can be covered with aluminium foil.
- For successful proving, a container of water should be placed in the bottom of the oven.

Cooking information table

Food	Weight (Kg)	Function	Shelf	Temp. (°C)	Time (minutes)	
Lasagne	3 - 4	STATIC	1	220 - 230	45 - 50	
Pasta bake	3 - 4	STATIC	1	220 - 230	45 - 50	
Veal roast	2	TURBO/CIRCULAIRE	2	180 - 190	90 - 100	
Pork loin	2	TURBO/CIRCULAIRE	2	180 - 190	70 - 80	
Sausages	1.5	FAN WITH GRILL	4	260	15	
Roast beef	1	TURBO/CIRCULAIRE	2	200	40 - 45	
Roast rabbit	1.5	CIRCULAIRE	2	180 - 190	70 - 80	
Turkey breast	3	TURBO/CIRCULAIRE	2	180 - 190	110 - 120	
Roast pork neck	2 - 3	TURBO/CIRCULAIRE	2	180 - 190	170 - 180	
Roast chicken	1.2	TURBO/CIRCULAIRE	2	180 - 190	65 - 70	
					1st surface	2nd surface
Pork chops	1.5	FAN WITH GRILL	4	260	15	5
Spare ribs	1.5	FAN WITH GRILL	4	260	10	10
Bacon	0.7	GRILL	5	260	7	8
Pork fillet	1.5	FAN WITH GRILL	4	260	10	5
Beef fillet	1	GRILL	5	260	10	7
Salmon trout	1.2	TURBO/CIRCULAIRE	2	150 - 160	35 - 40	
Monkfish	1.5	TURBO/CIRCULAIRE	2	160	60 - 65	
Turbot	1.5	TURBO/CIRCULAIRE	2	160	45 - 50	
Pizza	1	TURBO/CIRCULAIRE	2	260	8 - 9	
Bread	1	CIRCULAIRE	2	190 - 200	25 - 30	
Focaccia	1	TURBO/CIRCULAIRE	2	180 - 190	20 - 25	
Bundt cake	1	CIRCULAIRE	2	160	55 - 60	

The times indicated in the table do not include preheating times and are provided only as a guide.

Food	Weight (Kg)	Function	Shelf	Temp. (°C)	Time (minutes)
Tart	1	CIRCULAIRE	2	160	35 - 40
Ricotta cake	1	CIRCULAIRE	2	160 - 170	55 - 60
Jam tarts	1	TURBO/CIRCULAIRE	2	160	20 - 25
Paradise cake	1.2	CIRCULAIRE	2	160	55 - 60
Profiteroles	1.2	TURBO/CIRCULAIRE	2	180	80 - 90
Sponge cake	1	CIRCULAIRE	2	150 - 160	55 - 60
Rice pudding	1	TURBO/CIRCULAIRE	2	160	55 - 60
Brioches	0.6	CIRCULAIRE	2	160	30 - 35

The times indicated in the table do not include preheating times and are provided only as a guide.

CLEANING AND MAINTENANCE

Cleaning the appliance



See General safety instructions.

Cleaning the surfaces

To keep the surfaces in good condition, they should be cleaned regularly after use. Let them cool first.

Ordinary daily cleaning

Always and only use specific products that do not contain abrasives or chlorine-based acids. Pour the product onto a damp cloth and wipe the surface, rinse thoroughly and dry with a soft cloth or a microfibre cloth.

Food stains or residues

Do not use steel sponges and sharp scrapers as they will damage the surface.

Use normal, non-abrasive products and a wooden or plastic tool, if necessary. Rinse thoroughly and dry with a soft cloth or a microfibre cloth.

Do not allow residues of sugary foods (such as jam) to set inside the oven. If left to set for too long, they might damage the enamel lining of the oven.

Cleaning the hob

Cooking hob pan support grids

Remove the pan support grids and clean them in lukewarm water and non-abrasive detergent.

Make sure to remove any encrustations. Dry them thoroughly and return them to the hob.



The continuous contact between the pan supports and the flame can cause modifications to the enamel over time in those parts exposed to heat. This is a completely natural phenomenon which has no effect on the operation of this component.

Flame-spreader crown and burner caps

For easier cleaning, the flame-spreader crowns and the burner caps can be removed. Wash them in hot water and non-abrasive detergent. Carefully remove any encrustation, then wait until they are perfectly dry. Replace the flame-spreader crowns, making sure that they are correctly positioned in their housings with their respective burner caps.

Igniters and thermocouples

For correct operation the igniters and thermocouples must always be perfectly clean. Check them frequently and clean them with a damp cloth if necessary. Remove any dry

residues with a wooden toothpick or a needle.

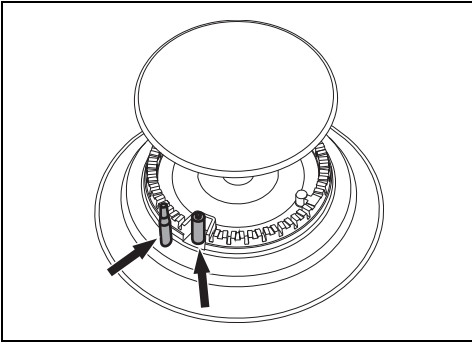

Knobs



Do not use aggressive products containing alcohol or products for cleaning steel and glass when cleaning the knobs, as these products could cause permanent damage.

The knobs should be cleaned with a soft cloth dampened with lukewarm water, then dried carefully. They can be removed by pulling them out from their housings.

Cleaning the door

Cleaning the door glazing

The glass in the door should always be kept thoroughly clean. Use absorbent kitchen roll. In case of stubborn dirt, wash with a damp sponge and an ordinary detergent.

Removing the door (auxiliary oven only)

For easier cleaning it is recommended to remove the door and place it on a tea towel.

To remove the door proceed as follows:

1. Open the door completely and insert two pins into the holes on the hinges indicated in the figure.

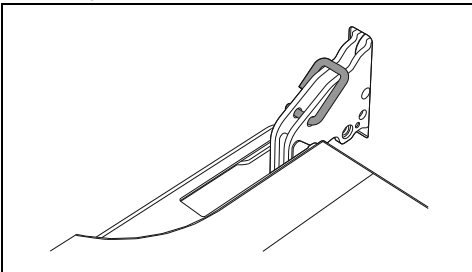

2. Grasp the door on both sides with both hands, lift it so that it forms an angle of around 30° and remove it.

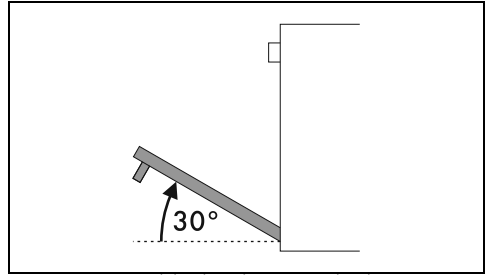

3. To reassemble the door, put the hinges in the relevant slots in the oven, making sure that grooved sections **A** are resting completely in the slots.

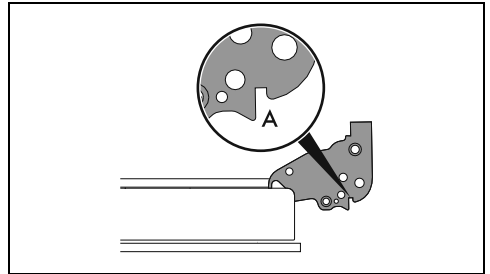

4. Lower the door and once it is in place remove the pins from the holes in the hinges.

Removing the internal glass panes

For easier cleaning the internal glass panes of the door can be removed.

1. Lock the door with the appropriate pins.
2. Remove the internal glass pane by pulling the rear part gently upwards, following the movement indicated by the arrows 1.

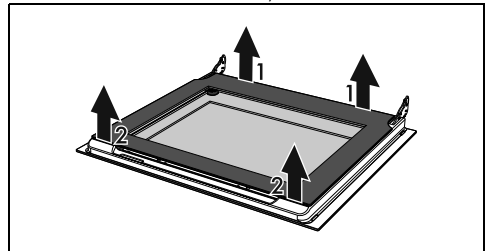

3. Release the front pins following the movement indicated by the arrows 2

4. Then remove the inner glass pane from the front profile.

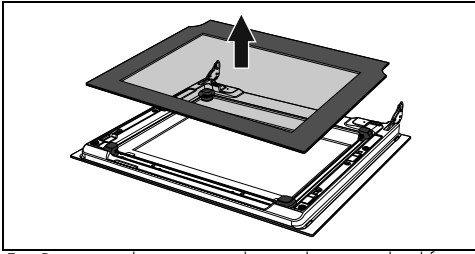

5. Remove the intermediate glass unit by lifting it upwards.

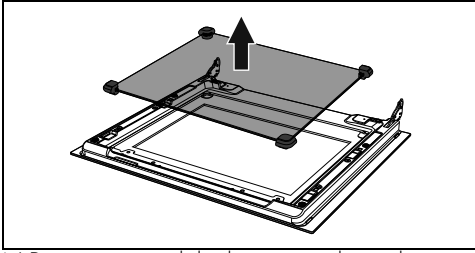

N.B.: in some models, the intermediate glass unit consists of two glasses.

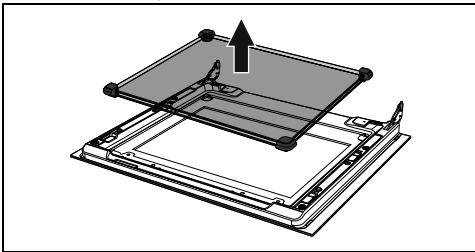

6. Clean the external glass pane and the panes removed previously.

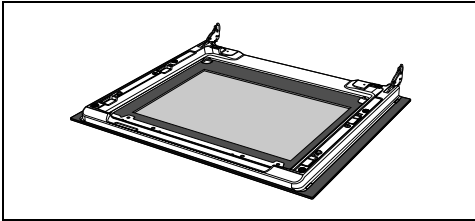

7. Use absorbent kitchen roll. In case of stubborn dirt, wash with a damp sponge and neutral detergent.

8. Reinsert the intermediate glass unit and reposition the inner glass.

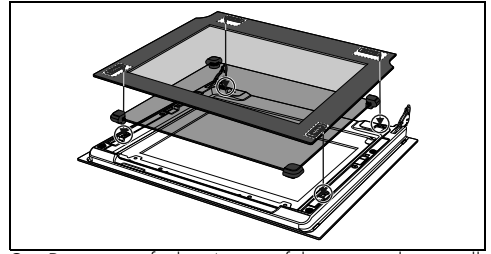

9. Be sure to fit the 4 pins of the inner glass well into their seats on the door.

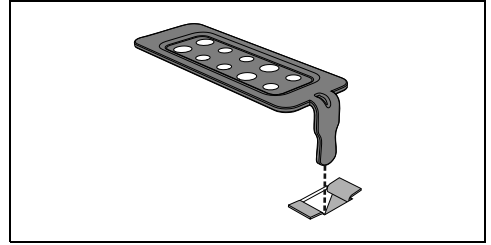

Cleaning the oven cavity

In order to keep your oven in the best possible condition, clean it regularly after letting it cool down.

Avoid letting food residue dry inside the oven cavity, as this could damage the enamel.

Take out all removable parts before cleaning. For easier cleaning, it is recommended to remove:

- the door;
- The rack/tray support frames.



In the event you are using specific cleaning products, we recommend running the oven at maximum temperature for 15-20 minutes in order to eliminate any residue.

Drying

Cooking food generates moisture inside the appliance. This is a normal phenomenon and does not affect the appliance's operation in any way.

Each time you finish cooking:

1. Let the appliance cool down.
2. Remove any dirt from inside the appliance.
3. Dry the interior of the appliance with a soft cloth.
4. Leave the door open until the inside of the appliance has dried completely.

Removing racks/trays support frames

Removing the rack/tray support frames enables the sides to be cleaned more easily.

To remove the rack/tray support frames:

- Pull the frame towards the inside of the oven cavity to unhook it from its groove A, then slide it out of the seats B at the back.

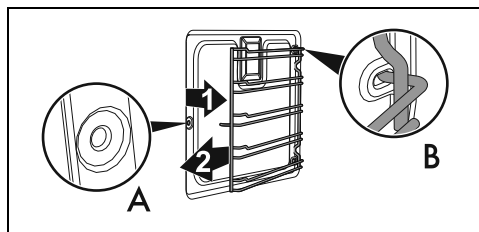

- When cleaning is complete, repeat the above procedures to put the rack/tray support frames back in.

Vapor Clean (on some models only)

 See General safety instructions.

 The Vapor Clean function is an assisted cleaning procedure that facilitates the removal of dirt. Thanks to this process, it is possible to clean the inside of the oven very easily. The dirt residues are softened by the heat and water vapour for easier removal afterwards.

Preliminary operations

Before starting the Vapor Clean cycle:

- Completely remove all accessories from inside the oven.
- Remove the temperature probe, if present.
- Remove the self-cleaning panels, if present.
- Pour approx. 120 cc of water onto the floor of the oven. Make sure it does not overflow out of the cavity.
- Spray a water and washing up liquid solution inside the oven using a spray nozzle. Direct the spray towards the side walls, upwards, downwards and towards the deflector.



 We recommend spraying approx. 20 times at the most.

 Do not spray the deflector if it has a self-cleaning coating.

- Close the door.

- During the assisted cleaning cycle, wash the self-cleaning panels (where fitted), which were previously removed, separately in warm water and a small amount of detergent.

Vapor Clean cycle setting

1. Turn the functions knob to symbol  or  (where present).
2. Turn the temperature knob to the  symbol.
3. Allow the cleaning cycle to run for 18 minutes.

Vapor Clean End

1. Turn the function knob to 0 to exit from the function.
2. Open the door and wipe away the less stubborn dirt with a microfibre cloth.
3. Use a non-scratch sponge with brass filaments on hard to remove deposits.
4. In case of grease residues use specific oven cleaning products.
5. Remove the residual water inside the oven.
6. Replace the self-cleaning panels and the rack/tray support frames, if fitted.

For greater hygiene and to avoid foods taking on unpleasant odours:

- We recommend drying the inside of the oven with a fan assisted function at 160°C for around 10 minutes.
- If self-cleaning panels are fitted, we recommend that you dry the inside of the oven with a simultaneous catalytic cycle.

 We recommend wearing rubber gloves for these operations.

 We recommend removing the door in order to make the manual cleaning of the parts that are difficult to reach easier.

Extraordinary maintenance

Seal maintenance tips

The seal should be soft and elastic.

- To keep the seal clean, use a non-abrasive sponge and wash with lukewarm water.

Replacing the internal light bulb



Power voltage
Danger of electrocution

- Unplug the appliance.
- Wear protective gloves.

1. Completely remove all accessories from inside the oven.
2. Remove the rack/tray support frames.
3. Use a tool (e.g. a spoon) to remove the bulb cover.

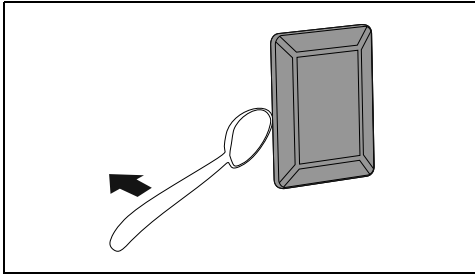

Take care not to scratch the enamel of the oven cavity wall.

4. Slide out and remove the light bulb.

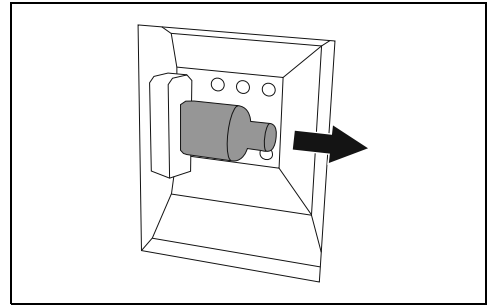

Do not touch the halogen light bulb directly with your fingers, use an insulating material.

5. Replace the light bulb with one of the same type (40 W).
6. Refit the cover. Ensure the moulded part of the glass (A) is facing the door.

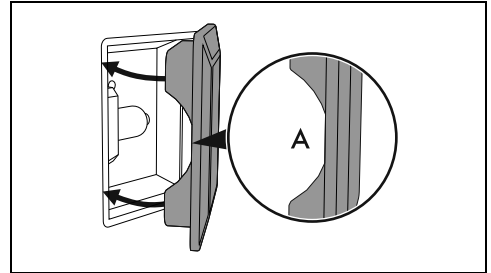

7. Press the cover completely down so that it attaches perfectly to the bulb support.

INSTALLATION



The appliance must be installed by a qualified technician and according to the regulations in force.



Appliance factory set for gas: NG pressure 1 kPa.

Gas connection



See General safety instructions.

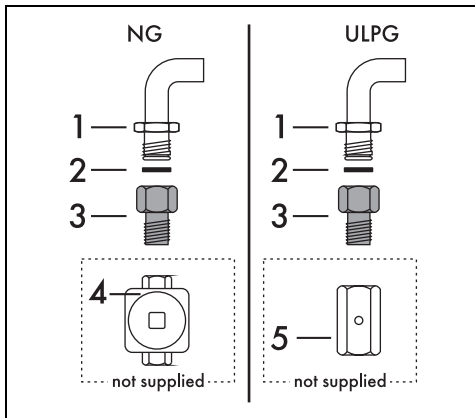

Carefully screw the connector 3 to the appliance's gas connector 1 (1/2" thread BSP), placing the supplied seal 2 between them.

For Natural Gas connect the appliance gas inlet (1 + 2 + 3) to the pressure regulator (4 - not supplied).

For Universal LPG connect the appliance gas inlet (1 + 2 + 3) to the test point adaptor (5 - not supplied).

This appliance must be installed by an authorised person in accordance with this instruction manual, AS/NZS 5601.1 – Gas installations (installation and pipe sizing), local gas fitting regulations, local electrical regulations, local health regulations, Building Code of Australia and any other government authority.

This appliance is suitable for connection with rigid pipe or flexible hose. The isolating manual shut-off valve connection point must be accessible when the appliance is installed.

Flexible hose assembly must be certified to AS/NZS 1869 class B or D, be of appropriate internal diameter for the total gas consumption (10mm), be kept as short as possible (not exceeding 1200mm), must not be in contact with the floor or any hot surface or sharp surface. The hose assembly must not be subject to strain, abrasion, kinking, deformation, contact with any other appliance or accidental contact with oven flue outlet of an under bench oven.

Gas leakage and operation of the appliance

must be tested by the installer before leaving. Check burner flames are blue in colour, stable and completely ignite at both high and low flame settings with no appreciable yellow tipping, carbon deposition, lifting, floating, lighting back or objectionable odour. Test burners individually and in combination. When satisfied with the operation of the cooker, please instruct the user on the correct method of operation

Natural Gas: the pressure regulator must be fitted to the appliance inlet connection. Gas pressure must be adjusted to 1.0 kPa when approximately 50% of the burners are on high flame, the appliance test point is located on the regulator.

Universal LPG: gas pressure must be checked to confirm the appliance operating pressure is 2.75 kPa.

1. Disconnect power.
2. Light the auxiliary burner and set to high flame. Ensure all other burners are off.
3. Zero manometer, then apply flexible tubing to seal over the Rapid burner injector, hold securely in place and check the gas pressure by pressing in the corresponding burner control knob in, then turning to high flame position.
4. If the pressure is 2.75 kPa, reassemble the burner and perform the final checks as per this instruction manual.
5. If the pressure is not 2.75 kPa, disconnect the appliance and check/adjust/replace the LPG cylinder regulator(s) as appropriate in accordance with AS/NZS 5601.

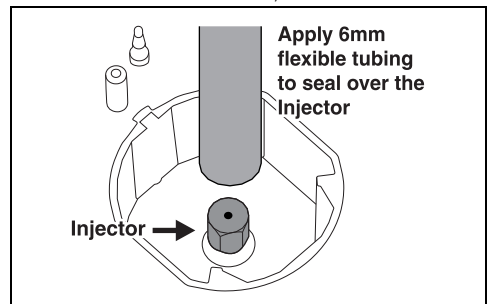

Patent 2015101170. For enquires contact
Gas Approval Consulting Pty Ltd Smeg
licence 037 for GSCS20265

Connection to LPG

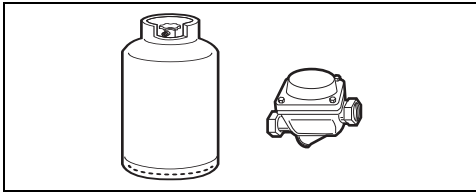

Use a pressure regulator and make the connection on the gas cylinder following the guidelines set out in the standards in force.

The supply pressure must comply with the values indicated in the "Burner and nozzle characteristics table".

Room ventilation

The appliance should be installed in rooms that have a permanent air supply in accordance with the standards in force. The room where the appliance is installed must have enough air flow for the regular combustion of gas burners.

The appliance should be installed in rooms with natural ventilation, as required by regulatory standard AS/NZS5601.

When the job is complete, the installer must issue a certificate of conformity.



The maximum height of the highest point of the pan support with respect to the surface that supports the appliance is 12 mm.

Adaptation to different types of gas

In case of operation with other types of gas, the burner nozzles must be changed and the minimum flame adjusted on the gas cocks.

Replacing nozzles

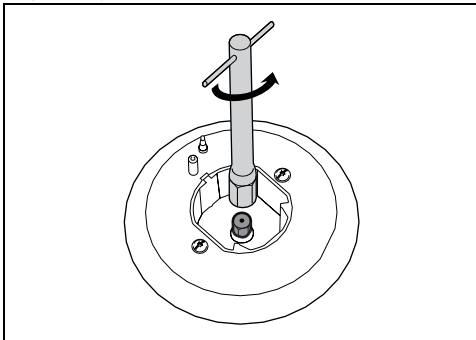

1. Remove the pan supports, burner caps and flame-spreader crowns to access the burner cups.

2. Replace the nozzles using a 7-mm wrench according to the type of gas to be used (see the "Burner and nozzle characteristics table").
3. Replace the burners in their respective housings.

Adjusting the minimum setting for natural gas

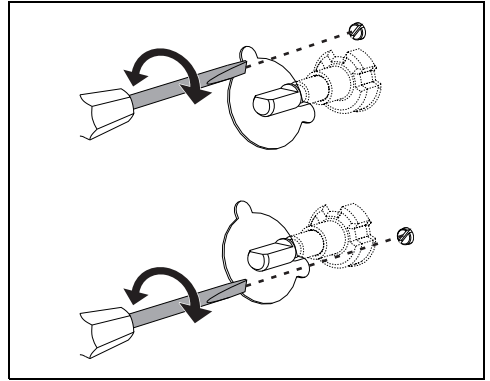

Light the burner and turn it to the minimum position. Extract the gas cock knob and turn the adjustment screw next to the gas cock spindle (depending on the model) until the correct minimum flame is achieved.

Refit the knob and verify that the burner flame is stable. Turn the knob rapidly from the maximum to the minimum setting: The flame should not go out. Repeat the operation on all gas cocks.

Adjusting the minimum setting for LPG

Tighten the screw located at the side of the cock spindle clockwise all the way.



Following adjustment to a gas other than the one originally set in the factory, replace the gas setting label on the appliance with the one corresponding to the new gas. The label is inserted inside the nozzle pack (where present).

Lubricating the gas cocks

Over time the gas cocks may become difficult to turn and get blocked. Clean them internally and replace the lubrication grease.



Lubrication of the gas cocks should be performed by a specialised technician.

Burner and nozzle characteristics tables

NG 1.0 kPA	AUX	SR	R	UR2
Nominal gas consumption (MJ/h)	3.9	7.5	12	15
Nozzle diameter (1/100 mm)	90	120	155	175
Reduced flow rate (MJ/h)	1.44	1.8	2.88	4.32
ULPG 2.75 kPA	AUX	SR	R	UR2
Nominal gas consumption (MJ/h)	3.9	6.3	10.8	15
Nozzle diameter (1/100 mm)	54	68	88	105
Reduced flow rate (MJ/h)	1.44	1.8	2.88	4.32

The nozzles not provided are available at Authorised Service Centres.

Positioning



See general safety instructions.

A: 600 mm (height), measured from the top of the highest burner and 750 mm from an exhaust fan. (a mechanical device other than a range hood for moving air from one interior space to another, or to outside of the space).

B: 200 mm (vertical combustible surface), measured from the edge of the nearest burner.

C: 10 mm or more (horizontal combustible surface) below the hob.

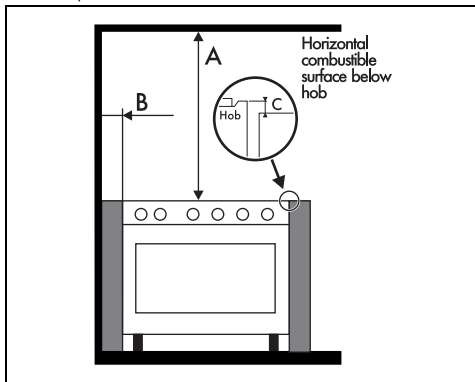

Refer to AS/NZS 5601 (Protection of combustible surfaces) if it is not possible to meet the minimum distances indicated above.



The supply connection point must be accessible with the appliance installed.



If a hood is installed above the appliance, refer to the hood instructions manual to make sure the correct clearance is left.

Appliance overall dimensions

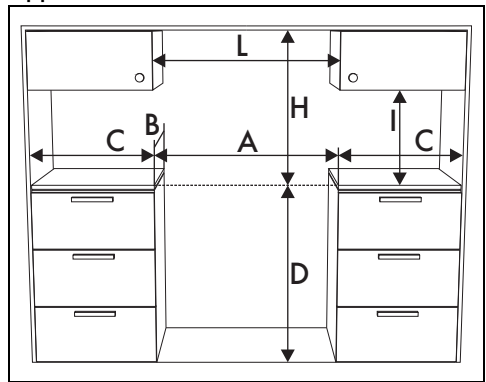

A	900 mm
B	600 mm
C ¹	min. 200 mm
D	879 - 919 mm
H ³	min. 600 mm
I	450 mm
L ²	900 mm

¹ Minimum distance from side walls or other flammable material.

² Minimum cabinet width (=A).

³ In the case of an exhaust fan min. 750mm.

Appliance dimensions

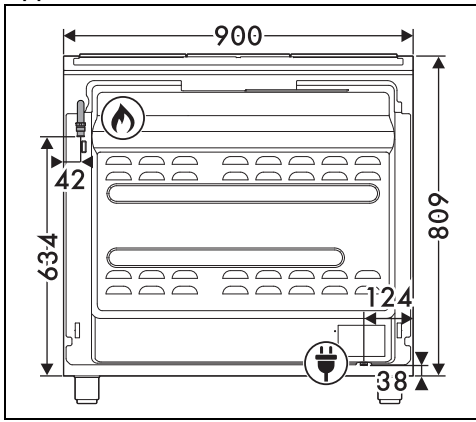

Position of gas connection



Position of electrical connection

Levelling the appliance



See General safety instructions.

The appliance must be level on the floor in order to ensure greater stability.

After making the gas and electrical connections, screw on the four legs supplied with the appliance (1). Screw or unscrew the feet at the bottom until the appliance is stable and level on the floor (2).

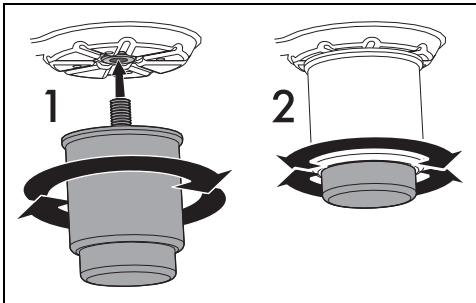

Assembling the upstand

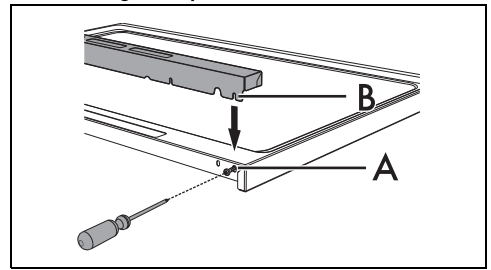

The upstand must always be positioned and secured correctly on the appliance.

1. Loosen the 2 screws (A) on the back of the hob using a screwdriver (only loosen the outermost ones).
2. Place the upstand on the hob.
3. Align the slots of the upstand (B) with the screws (A).



The upstand provided is an integral part of the product. It must be fastened to the appliance prior to installation.

Fastening to the wall

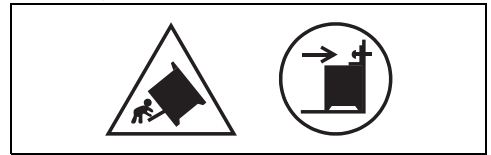

The symbols above indicate the danger if the anti-tip are not installed devices and the importance of their correct installation.



The anti-tip devices must be installed in order to prevent the appliance from tipping over.

1. Screw the wall fastening plate to the rear of the appliance.

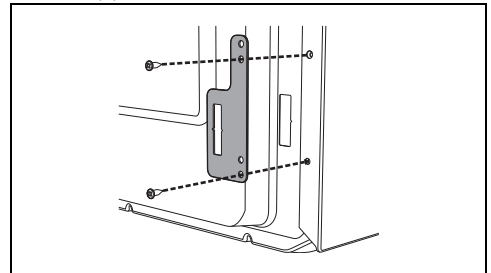

2. Adjust the height of the 4 legs.

3. Assemble the fastening bracket.

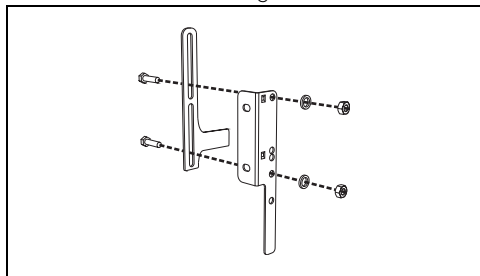

4. Align the base of the hook on the fastening bracket with the base of the slot on the wall fastening plate.

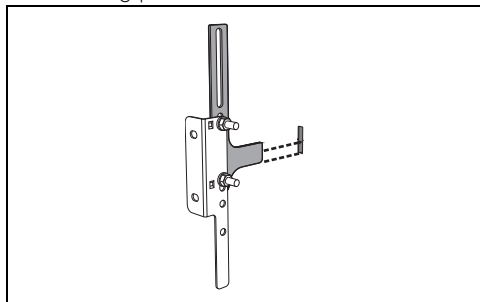

5. Align the base of the fastening bracket with the ground and tighten the screws to fix the measurements.

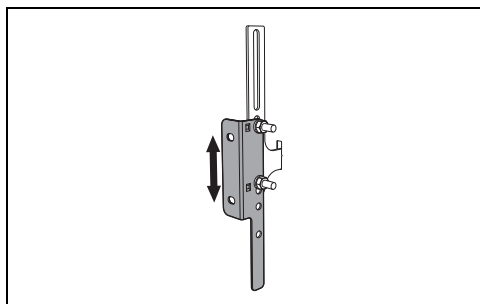

6. Consider a distance of 50 mm from the side of the appliance to the bracket holes.

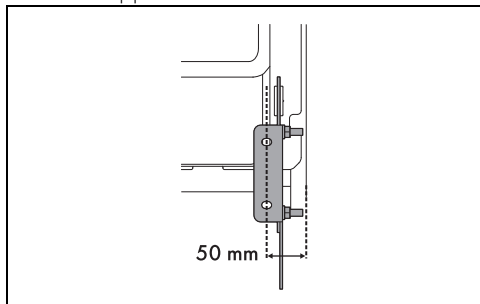

7. Move the bracket onto the wall and mark the position of the holes to be drilled in the wall.

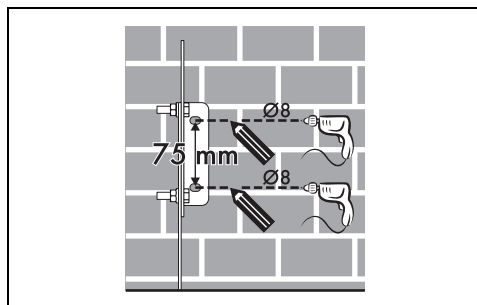

8. After drilling the holes in the wall, use wall plugs and screws to fasten the bracket to the wall.

9. Push the cooker towards the wall, and at the same time insert the bracket in the plate fastened to the rear of the appliance.

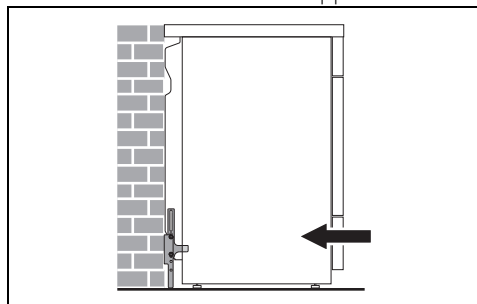

Fastening to the wall with a chain

1. Unscrew the screw behind the hob near the gas connection.

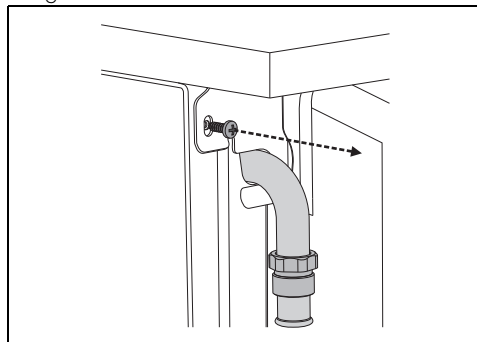

- Attach the chain to the cooker using the screw that was removed in the previous step.

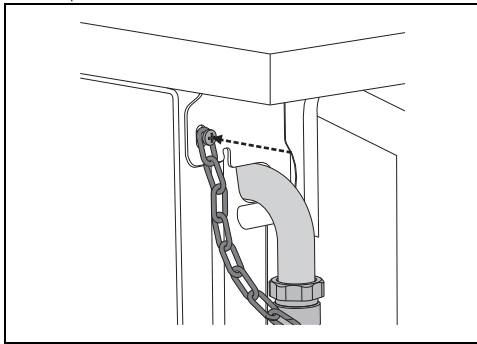

- Stretch the chain out horizontally so that the other end touches the wall. Mark the position for the hole on the wall.

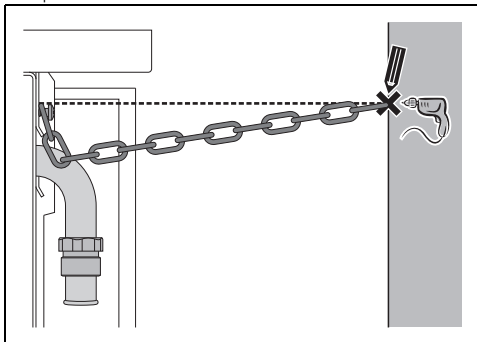

- Drill a hole at the marked position and insert a wall plug.
- Attach the chain and place the appliance against the wall.

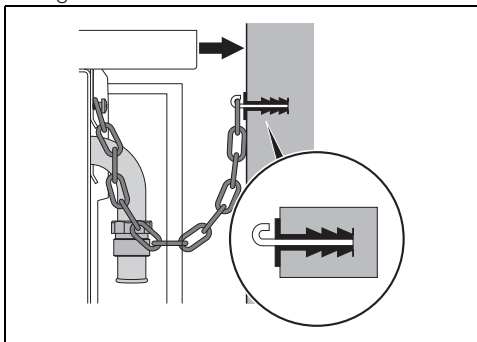

 The length of the chain must be as short as possible to prevent the appliance from tipping forwards or diagonally or from moving sideways.

Electrical connection



See General safety instructions.

General information

Check the mains characteristics against the data indicated on the plate.

The identification plate bearing the technical data, serial number and brand name is visibly positioned on the appliance.

Do not remove this plate for any reason.

The appliance must be connected to ground using a wire that is at least 20 mm longer than the other wires.

The appliance can work in the following modes:

220-240 V 1N~

3 x 1.5 mm²

three-core cable

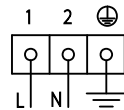

The values indicated refer to the cross-section of the internal conductor.



The aforementioned power cables are sized taking into account the coincidence factor (in compliance with standard EN 60335-2-6).

Fixed connection

Fit the power line with an all-pole circuit breaker with a contact separation distance sufficient to provide complete disconnection in category III overvoltage conditions, pursuant to installation regulations.

For the Australian/New Zealand market:

The circuit breaker incorporated in the fixed connection must comply with AS/NZS 3000.

Connection with plug and socket

Make sure that the plug and socket are of the same type.

Avoid using adapters, gang sockets or shunts as these could cause overheating and a risk of burns.

Instructions for the installer

- If you use a plug to connect to the power supply, the plug must be accessible after installation.
- Do not bend or trap the power cable.
- The appliance must be installed according to the installation diagrams.

- Do not try to unscrew or force the threaded elbow of the fitting. You may damage this part of the appliance, which may void the manufacturer's warranty.
- Use soap and water to check for gas leaks on all connections. DO NOT use naked flames to search for leaks.
- Turn on all the burners separately and at then all together to make sure that the gas valve, burner and ignition are working properly.
- Turn the burner knobs to the minimum position and check that the flame is stable for each individual burner and all the burners together.
- If the appliance does not work correctly after having carried out all the checks, contact your local Authorised Service Centre.
- Once the appliance has been installed, please explain to the user how to use it correctly.